

Home Of the "Little Green Tipplers..."

ALL Prices  
inclusive of  
GST

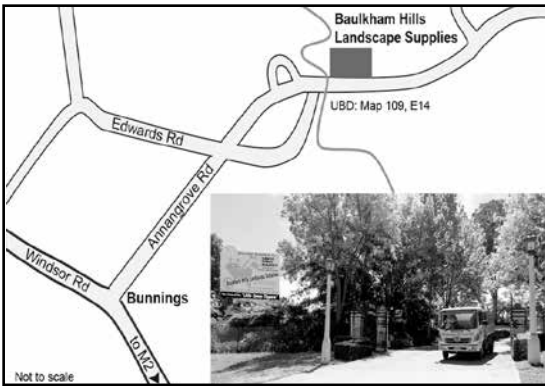

# Product Guide

Effective Spring 2016 although some prices may change without notice

**"Now you have 458 different landscaping materials to choose from to make your home & garden more attractive, practical and enjoyable."**

As you landscape your home you'll really add true value to your property. That's why the team at **Baulkham Hills Landscaping Supplies & AMBER Kellyville** are dedicated to providing you with the highest quality materials & best service. So landscaping your home will be fun, easy and rewarding.

Once you've made your choice, one of our friendly yardsmen will help you load your ute, boot or trailer. Or, if you prefer you can phone through your order and we'll deliver.

You see, we have a large fleet of big and small "little green tipplers" to deliver to your door!

For **FREE** advice

# 9629-2000

[www.landscape-supplies.com.au](http://www.landscape-supplies.com.au)

We are open and deliver *anywhere*  
7 days a week!

Monday - Friday	7.00am - 5.00pm
Saturday	7.00am - 4.00pm
Sunday & Public Hols	9:00am - 3.30pm

We are closed Anzac, Easter & Chrissy\Boxing & NYDay.



"Some of our Little Green Tipplers"



Selecting the right products for your garden is easy. You'll get dozens of great landscaping ideas as you wander through our 3.2 acres of quality materials and displays.

Plus, you can talk to any of our trained team who will be more than happy to advise you on how to create your dream garden.



**in the grounds of Regal Gardens  
249 Annangrove Rd ANNANGROVE**

## Our Guarantee To You

*It's our aim to make sure you are completely delighted with the materials and service you receive from us. If for any reason you are not, simply let us know and we will do everything we possibly can to make things right or we will refund your investment in full.*



some of our helpful staff

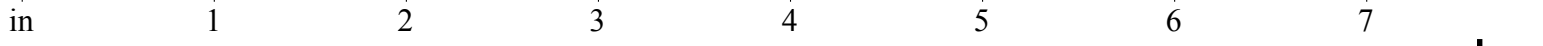

**SO** **Organic SOIL MIXES** *per Cubic m*

Whether a growing medium is a natural soil or a manufactured soil blend, it must have 5 major components : Mineral Particles (eg sand); Organic Matter ; Air ; Water and Micro Organisms. The natural soils we have at home are generally heavier than desired & lack the organic or nutrient balance required for good plant growth, turning muddy when wet and caking when dry. Because of the wide range of jobs these mixes have to perform, we have produced 11 different blends to suit your varied needs.

<b>ULTRA-GRO GARDEN MIX ( &amp; all Special Mixes)</b>	<b>UGM</b>	<b>Bag - \$1 empty</b>	<b>Half m<sup>3</sup></b>	<b>m<sup>3</sup></b>
		<b>\$6.50</b>	<b>\$34</b>	<b>\$63</b>

The very best of planting mixes consisting of Sandy Black Loam, Spent Mushroom Compost, Washed Ash, Manures, Peat Substitute and Bark Fines. A screened mix that is ideal for all flowers, shrubs and vegetables, has a suitable pH that is not too rich for Grevillias and other natives

<b>NATIVE MIX</b>	<b>NM</b>	<b>\$7.50</b>	<b>\$32</b>	<b>\$58</b>
-------------------	-----------	---------------	-------------	-------------

A specialists mix for native plants that can't handle those high levels of phosphates and Lime.

<b>PREMIUM ORGANIC MIX</b>	<b>POM</b>	<b>\$6.50</b>	<b>\$31</b>	<b>\$57</b>
----------------------------	------------	---------------	-------------	-------------

A sturdy and very nutrient rich garden soil that drains well. Contains Sandy Loam, Spent Mushroom Compost, Washed Ash, & Manures. Our POM contains almost **50% organic matter** to aid water retention. It can be used in all types of garden beds, though care should be taken with some sensitive native plants and Azaleas.

<b>ORGANIC MIX</b>	<b>OM</b>	<b>\$6.50</b>	<b>\$30</b>	<b>\$54</b>
--------------------	-----------	---------------	-------------	-------------

A budget mix popular with Landscapers. Contains Sandy Loam, Spent Mushroom Compost & sawdust for friability. OM contains almost **30% organic matter** to aid water retention.

**Cubic Metres vs. Tonnes? This is an often asked question when comparing prices as the ratio will vary according to the proportion of organic matter used in the mix. Generally when comparing OUR Organic mixes, other people use the ratio 1.3Tonnes = 1 cubic metre. For Metal\Gravels, use 1.6T & Roadbase 1 cub = 1.9Tonne.**

**TS** **TOP DRESSING** *per Tonne*

<b>ULTRAGRO TOP DRESSING</b>	<b>UTD</b>	<b>\$6.50</b>	<b>\$37</b>	<b>\$69</b>
------------------------------	------------	---------------	-------------	-------------

A finer blend than our regular TD consisting of 80\10\10 river sand, soil & ground chicken manure. For those "Bowling Green" lawns this an ideal top dressing. Use in autumn & spring when the chicken manure provides extra nitrogen, just like the turf farms.

<b>SPECIAL BLEND TOP DRESSING</b>	<b>SBTD</b>	<b>\$6.50</b>	<b>\$31</b>	<b>\$55</b>
-----------------------------------	-------------	---------------	-------------	-------------

Our most popular mix with screened Sandy Loam, Saw Dust and Chicken Manure, it has a light clean texture making it easy to spread and you will see the difference under 5 days.

<b>TOP DRESSING</b>	<b>TD</b>	<b>\$6.50</b>	<b>\$28</b>	<b>\$52</b>
---------------------	-----------	---------------	-------------	-------------

Most Greenkeepers & Councils specify a 70\30 mix of screened river sand and virgin, black soil and this is the basis of our mix. Depending on your lawn however, we will blend to any formula you wish. Just ask one of our staff who will be happy to assist.

**TU** **TURF UNDERLAYS\***

With the move to conservation in the building industry, we are proud to introduce a recycled range of soils; some suitable as an underlay or turf starter or as a base for a garden bed. **CAUTION: this range is NOT suitable as a Top Dressing as recycled soils may contain building debris such as glass that may interfere with lawn mowers & can be flung as a projectile.**

<b>TURF STARTER UNDERLAY *Not suitable as Top Dressing</b>	<b>TU</b>	<b>\$6.50</b>	<b>\$26</b>	<b>\$47</b>
--	-----------	---------------	-------------	-------------

<b>SPECIAL BLEND TURF UNDERLAY *Not suitable as a Top Dressing.</b>	<b>SBTU</b>	<b>\$6.50</b>	<b>\$28</b>	<b>\$52</b>
---	-------------	---------------	-------------	-------------

Same formula as our regular SBTU but at a cheaper price!

**FILL MATERIAL** Where you have an area that is deeper than 500mm, you may like to consider using *Fill Soil*, either screened or unscreened, depending on the application. Again this is a re-cycled product & may contain building debris such as glass, broken tile, chards of wood & aggregates. The pH is also HIGHLY acidic so we stress that it is **Not suitable as a direct Turf Underlay!**

**SO** **POTTING MIXES**

<b>PLANTER BOX MIX</b>	<b>PBM</b>	<b>n/a-</b>	<b>\$59</b>	<b>\$63</b>
------------------------	------------	-------------	-------------	-------------

A very open mix of Composted Bark Fines and Course Sand, made for use in the nursery industry. Ideal for plants that don't like being too wet. Regular application of a liquid fertilizer (eg Fish Emulsion) as well as the use of slow release pellets will ensure the plants will thrive.

<b>ULTRA POTTING MIX</b>	<b>UPM</b>	<b>\$8.75</b>	<b>\$79</b>	<b>\$95</b>
--------------------------	------------	---------------	-------------	-------------

The addition of *Peat like* material produces an excellent potting mix that retains more moisture and gives the plants a welcome boost on planting. Continue to fertilize regularly as nutrients leak out of pot plants very quickly.

**MU****MULCHES****How does mulch benefit your garden ?**

A mulch is a material applied to the surface of the soil. By blocking the sun and protecting the soil from wind and the extremes of heat and cold, mulch conserves the soil moisture, moderates soil temperature, controls weeds, maintains the physical structure of the soil and prevents soil erosion.

Mulch can be categorised into decorative (*see gravels & pebbles*) or a *True Mulches* which degrease over time and thus provide a continual slow release of natural nutrients. Mulch looks great too. Gone are the days of the one and only "bark". You'll be amazed at the new look and feel of alternatives.

**How much material will you need ? (1Cubm=10m2)**

Just take the area in m<sup>2</sup> (*length x Breath*) and divide by 10. Average depth should be (50-75mm).

If the area is small, we have bags of most mulches.

**14 bags of mulches = 1 m<sup>3</sup> & 40 bags sand\soil = 1Tonne**  
**Using Deco Pebbles = 10 bags covers 1 sq m.**

**When top dressing = 1 Tonne covers 40 sq m. "lightly".**

**Formulas: Triangle = 1/2 base x height. Circle = Pi x Radius<sup>2</sup>**

Bag -\$1 empty	Half m <sup>3</sup>	m <sup>3</sup>
----------------	---------------------	----------------

CYPRESS MULCH	\$7.90	\$44	\$83
---------------	--------	------	------

A reddish mottled colour, smaller in size than our Eucalpt Mulch. Ideal for native and formal areas. *Not a Unimulch; All Cypress!*

EUCALYPT MULCH	\$7.90	\$42	\$75
----------------	--------	------	------

The finest of mulches! Cut from native eucalpts. Smaller in size than most woodchips and does not fade. Rich aromatic fragrance when wet. Ideal for native and formal areas.

Eucal (Hardwood) Flake	\$7.90	\$37	\$69
------------------------	--------	------	------

A *new style* mulch that consists of 50-75mm slivers of virgin *Eucalypt Maculata* (Spotted Gum) tailings that is becoming popular with home gardeners. Excellent on sloped areas where the natural matting prevents soil erosion. *White ant tolerant & my personal favorite!*

CYPRESS PINE CHIPS	\$7.90	\$39	\$72
--------------------	--------	------	------

A honey/brown mottled chip in 40mm screenings. A popular choice by Councils since the species of Cypress do not attract insects such as white ants.

PINE BARK Med-25	\$7.90	\$39	\$72
------------------	--------	------	------

These medium golden nuggets make this a very popular bark with its soft texture making it suitable for your indoor or outdoor landscape

PINE BARK Sm -QLD	\$7.90	\$42	\$74
-------------------	--------	------	------

A product sourced from QLD because its all BARK! Often used in potting mixes and soil blends. Its delicate texture and golden brown colour also mean its ideal for mulching small gardens, heavily planted areas and indoor settings.

PINE BARK SOFTFALL	\$9.90	\$42	\$75
--------------------	--------	------	------

A Certifiable blend of *Cupped & Hammered* Pinebark specified by PLAYSAFE AUST. for in & around playground areas. Should be minimum 150mm thick.

WOOD CHIP (Hardwood)	\$7.90	\$33	\$62
----------------------	--------	------	------

A reddish brown colour with long lasting qualities. Made up of 25-40mm chips of hardwood waste material from the timber industry.

REDWOOD WOOD CHIP	\$7.90	\$39	\$72
-------------------	--------	------	------

(*Colour enhanced by Pigmentation*)

A terracotta dyed woodchip made from re-cycled wood that holds its colour for months.

Bag -\$1 empty	Half m <sup>3</sup>	m <sup>3</sup>
----------------	---------------------	----------------

\$7.90	\$31	\$57
--------	------	------

**RADIATA PINE CHIP (Screened)**

A light honey \cream coloured chip, quite uniform in its gradings (abt 40mm) - a great value mulch that is long lasting & does the job well.

Leaf Mulch	\$7.90	\$17	\$30
------------	--------	------	------

A blend of *at least 12 week composted* leaf & tree cullings & wood waste from the timber industry. Ideal as a Native mulch or under deciduous trees.

**PS. In the initial 12 weeks, leafmulch will compost down by approx. 30%. In doing so the composting fresh leaves give off heat which will actually draw nitrogen & thus deprive your plants! Insist on OLD LEAFMULCH!**

**ADDITIONAL MULCHES****ULTRAGROW HUMUS MIX**

Just what the doctor ordered ! A rich blend of Mushroom Compost, Manures, Washed Ash, Composted Sawdust, Peat and Composted Bark Fines that can be used with poor soils to increase the level of organic matter and nutrient levels. Don't use as a growing medium on its own (*better to use Ultra Gro or Premium Organic Mix*). Ideal for rejuvenating old garden beds.

\$7.50	n/a-\$42	\$59
--------	----------	------

**BOTANY HUMUS MIX**

Same as Ultra Grow but with the addition of Mineral Sands for heavier (e.g. clay) soils so it leaves it more friable.

\$1.50-TOS	\$17	\$30
------------	------	------

**MUSHROOM COMPOST (Bulk Only)**

An old favourite as a cost effective source of natural compost. The pH of this mulch can become quite high (alkaline) which can cause problems for some plants. Be sure it is aged to at least 12 weeks old.

\$5.25 25L	\$42	\$80
------------	------	------

**COW MANURE (SCREENED)**

Not just Cow Pats ! Dark black and soil like in appearance, Cow Manure is an excellent source of major nutrients and trace elements with a neutral pH.

CHICKEN MANURE	\$6.50	\$19	\$33
----------------	--------	------	------

Aged Chicken manure in a sawdust carrier. Ideal for any plants/lawn

**STRAW BALES**

\$18.50 bale
--------------

Farmers bale, tied with twine. *May not be suitable for livestock!*

LUCERNE HAY Baled in Plastic	\$23.25 in plastic
------------------------------	--------------------

New Product, encased in plastic for ease of transport

**Sugar Cane Mulch**

\$15
------

Again with conservation in mind, this product is ideal as a mulch. Comes in layered biscuits to make spreading easier.

**Coverage is approx. 2 bales=10 sq. m. to dep 75mm**



## SA SANDS

	BAG	1/2T	1T
(50/50) Yellow.....	\$6.50	\$34	\$63
(50/50) White.....	\$6.50	\$38	\$68
<i>Coarse</i> Washed Riv Sand	\$6.50	\$42	\$74
<i>Fine</i> Washed River Sand	\$6.50	\$39	\$72
<b>Paving BlendAS*</b>	\$7.50	\$37	\$69
Sydney Sand	\$6.50	\$37	\$69
<b>Blue</b> Crusher Dust (6mm minus)		\$36	\$68
Fill Sand- <i>Unscreened Virgin</i>		\$24	\$44
Recycled Concrete Fines		\$24	\$43

\*PBAS is the only sand we sell that complies to *Aust Standards for paving.*

## SA FILLING & COMPACTING MATERIAL

	1/2T	Tonne
Road Base - 20mm.....	\$34	\$64
DGB20 Road Base ( <i>RTA specs</i> ).....	\$37	\$69
Metal Dust (Blue).....	\$38	\$68
Ash.....per cub m.....	\$26( <i>CubM</i> )	\$47
Recycled Fines.....	\$24	\$43
Recycled Concrete AGG-20&10mm	\$30	\$54
Recycled Concrete Road Base	\$26	\$47
Recycled Asphalt		\$46
Fill Soil ( <i>Nb. not suitable as TS; nosand</i> )		\$30

## Peb DECORATIVE PEBBLES & Gravels

<i>Pea Gravel</i>	\$9.75	\$56	\$108
<i>20mm Round..</i>	\$9.75	\$56	\$108
<i>40mm Round..</i>	\$9.75	\$56	\$108
<i>Lucky Stones.....</i>	n/a bag	\$58	\$110
<i>Gabion Spalls 150-300</i>		\$58	\$110
<b>White Pebble</b>			
20mm	\$12	\$107	\$209
40mm	\$12	\$107	\$209
<b>Gold Pebble</b>			
20mm	\$12	\$107	\$209
<b>Cream Gravel</b> 20mm		\$ 90	\$175
<i>this is a crushed gravel with sharp angular edges- not pebble like</i>			
<b>(Riverina) Red Gravel</b>			
14mm & 20mm...\$12	\$ 101		\$198
<b>Volcanic Rock</b>			
<i>Scoria-Red-14mm</i>	\$ 9.75	\$92	\$180 <sup>cub m</sup>
<b>Decomposed Granite Pink</b>	\$8	\$46	\$84
<b>Decomposed Granite Gold</b>	\$8	\$46	\$84
<b>Blue Metal</b> 10&20mm	\$6.50	\$42	\$79
<b>Post Hole Mix - Bulk</b>	\$7.50	\$46	\$84



## RO ROCKS & BOULDERS

Our customers tell us that they want specific sized / shaped rocks. To assist, we have graded our bush rock into 4 main sizes which you may select as individual pieces or per metre !

**BUSH ROCKS**

Small .....	\$7.50	pc
Medium .....	\$9.95	pc
Large .....	\$11.95	pc
Feature.."one man rock-less 40Kg"....From ...	\$19.00	pc
Per Square Metre .....	\$ 95.00	pm
Per 10 Metre Load ( <i>incl. local delivery</i> ) .....	\$850.00	Ld

**SANDSTONE**

Flagging.....	\$74 per square metre
Dimensional Blocks.....	\$76 per square metre
Sawnstone cut to order	Price On Request
Crazy Pave 50mm sawn offcuts	\$85 sq.m

## CEMENT & PRE MIX

**How much cement do we need?**  
*This is an often asked question, made more difficult when dealing with small quantities. As a general rule you will need*

<b>1 m concrete</b>	=3 metal:	2 sand:	1 Cem.
	1.25 T:	1T:	14 bags
<b>To lay</b>	1000 face bricks	1.0T	12 bags
	1000 commons ( <i>with frog</i> )	1.3T	12 bags
	700 Besser blocks-20.42	1.5T	12 bags
<b>Core Fill</b> 150	" " "	1.5T	15 bags

**Cement** 20Kg

Boral Premium Grey.....	\$8.75
Boral GP .....	\$9.00
Boral Off White .....	\$10.50
Rapid Set .....	\$7.95
Concrete Mix - <b>with</b> Blue Metal .....	\$7.45
Sand & Cement - <b>No</b> Blue Metal .....	\$7.45
Mortar Mix-Sand&Cem <b>with lime</b> .....	\$7.95
Lime Plaster's .....	\$15.75
UniRender ( <i>Premixed Cement Render in a bag</i> ).....	\$16.95
Render's Clay .....	\$15
Interlok ( <i>Jointing sand for paving c/w water based silicone beads &amp; kiln dried sand - (Amber exclusive)</i> )20Kg.....	\$21.63

**Plasticiser - Bycol**

1 litre .....	\$10
5 litre .....	\$21
20 litre .....	\$59
<b>Bonding Agent - Bondcrete</b>	
1 litre .....	\$29
2 litre .....	\$39
4 litre .....	\$69
<b>Cemstick -20L Tradesman Quality Bonding agent....</b>	\$166
<b>Expansion Joint (all 2.44 m 8' length)</b>	
50mm (2") .....	\$ 5.95
75mm (3") .....	\$ 7.50
100mm (4") .....	\$ 8.25
150mm (6") .....	\$12.95

*We also carry an extensive range of building accessories for the handyman such as Bricktor, Wire Ties, and Dampcourse, in various widths.*

# AC ACCESSORIES LANDSCAPE

**BLACK PLASTIC - 2m & 4m wide**  
 5m x 2m x 100um..... \$ 8.95 roll  
 10m x 2m x 100um..... \$16 roll  
 20m x 2m x 100um..... \$28 roll  
**50m x 2m x 200um Thick \$ 88 roll**  
**50m x 4m x 200um Thick \$165 roll**

**ORANGE PLASTIC - 200um**  
 50m x 2m x 200um ..... \$3.50m \$117  
 50m x 4m x 200um ..... \$5.50m \$166

**AGFLEX DRAIN COIL**

	10m	20m	50m
50mm	\$20	\$39	
65mm	\$21	\$41	\$ 99
100mm	\$28	\$48	\$149

*ALSO Unslotted pipe & Y JOINERS*

**AGFLEX DRAIN COIL with Sock**

	10m	20m	50m
65mm	\$28	\$58	\$149
100mm	\$45	\$88	\$199

	Per/1m	50m
<b>WEED CONTROL MAT (WCM)</b>		
910m wide.....	\$1.50	\$45
1.8m wide.....	\$2.00	\$75
<b>GEOFABRIC (Bidim)</b>		
600mm wide.....	\$1.85	\$ 60
1m wide...	\$2.30	\$ 79
2m wide.....	\$4.65	\$158
Silt Fencing-1980	\$2.65	\$ 99
Silt Environmental Barriers		
750 x 200mm dia	\$19.95	3+ \$16.95

**HARDWOOD PEGS**

	Ea	Pack Unbroken	Pak Size Bundle
12" (50x50mm).....	\$2.50	\$27	12pcs
<b>12" Surveyor Pegs.....</b>		\$15 <i>Pak only</i>	12pcs
18" (50x50mm).....	\$.3	\$33	12pcs
24" (1.5 x 1.5").....	\$2.50	\$27	12pcs

**GARDEN STAKES**

	Ea	Pack Price Unbroken	Bundle
4' x 25mm Pointed	\$2.50	\$18	- 6pcs
5' x 48mm Pointed	\$8	\$21.50	- 3pcs
6' x 25mm Tomato	\$3.25	\$17.50	6pcs
6' x 38mm Tree stake	\$6.25	\$33.50	- 6pcs

**TREATED PINE EDGE BOARDS**  
 200x50mm suitable for inground use  
**2.4m length \$19.85**  
**3m length \$24.75**

**MISCELLANEOUS DR**

Sewer Pipe with collar 4" \$20

Stormwater 90 x 6m HD \$29  
 Acid 15L(+Dep \$15) \$22.75

**BB Bricks -**

	<2000	2000+
Commons Extruded 89c	\$810\1K	\$810\1K
Solid bricks	\$1.25	\$1100\1K

**Handy Mesh, Gal & Plain**  
 Additional Delivery Fees apply

\*\*\*\* CAUTION \*\*\*\*

*As our suppliers change regularly, we are unable to guarantee that product supplied is identical to the samples on display. Aggregates & mulches vary in colour, whilst sizing may also vary. If you are unsure, ask to see the actual stockpile. E&O.A.*

# DR DRAINS & CHANNELS

**Plastic - Channel & Grate**  
 1.0mx100x85mm inc. Grate - \$22  
 End Cap \$5.50

**EVERDRAIN - Channel & Grate**  
 1.0m Length x 125 x 125mm inc.  
 Grate - \$TBA End Cap \$TBA

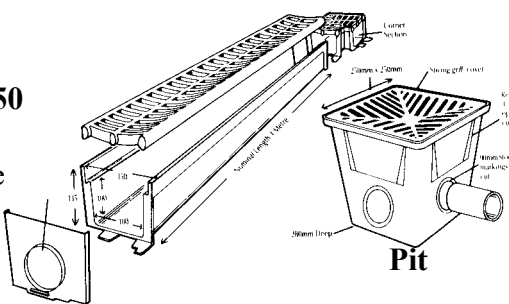

**RAINWATER PIT & Grate**

	Plastic	Alum
250 x 250x 285mm	\$21.25	\$25.50
300 x 300x 300mm -	\$36.95	\$50
450x450x600mm	n/a	\$205
710x710x650mm		\$tba

# BB CONCRETE SLABS & GRATES

## CONCRETE

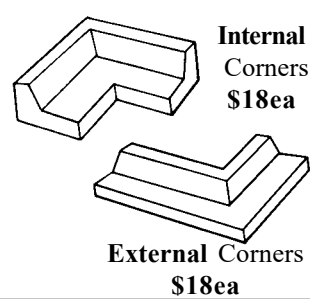
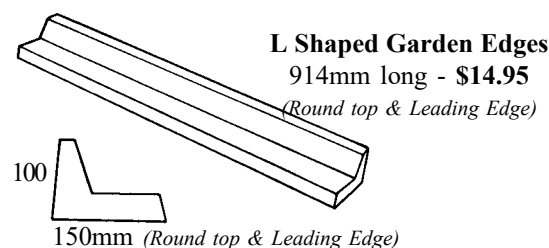

## GRATES

*Various available to suit the above*

450x450 Gal Steel \$129

## UNIPIT

200x200 inc. Plastic Grate \$19.95  
 Sandstone & Terracotta \$35  
*(Powder coated Aluminium)*

## TREE SURROUNDS *BB*

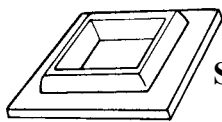

**Squares Full**

**Large \$35**

Stop Press *New low profile design*

ID = 430mm, OD = 640mm

Height = 60mm

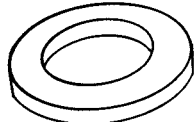

*Discontinued*

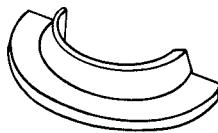

**Half Round Large - \$18.75 per half**

ID = 450mm, OD = 750mm

**Small - \$13.25 per half**

ID = 300mm, OD = 600mm

Overall height for both = 100mm

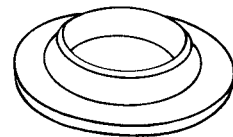

*To be discount.*

**Full Round Large - discount**

**Small - discount**

## PAVING SLABS *BB*

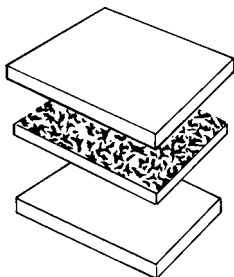

Handislabs

*New Handislabs*

Ripple

610-610mm : \$18.95

610 -450mm \$17.50

500 -500mm \$17.50

450-450mm : \$14.95

330-330mm : \$ 8.95

300-300mm : \$ 4.95

400-400mm : \$ 8.95

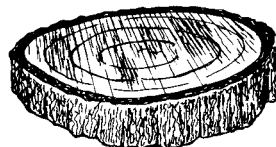
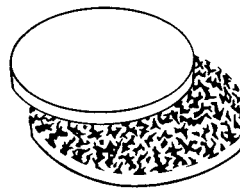

*Discontinued*

## STEPPING ROUNDS

Ripple

400mm : \$12.90

330mm : \$ 9.75 ea.

*Handislabs are ideal for floor in sheds as they are easy to lay & can be taken up if you wish to relocate or remove your shed!*

## *TI*

## TIMBER & GARDEN EDGING

**Rola-Paks (3m length)**

*Discontinued*

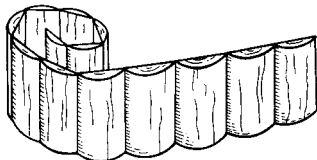

**30m Flexi Edge** UV plastic. Ideal for curves. \$130

**3m 30m Link Edge** Aluminium Edge system fr.\$40

**Treated Pine Edge Boards**

200x50mm 3m \$24.75 2.4m \$19.85

100x25mm 4.8m \$16

**Brick Edges & Pavers**

\$8 Per Lin.m.

Handiedge 400mm \$11.95

**Other Suggestions for Edging :**

*Sleepers  
Flagging  
Bushrock  
Garden Wall  
Pavers  
Sandstock Bricks*

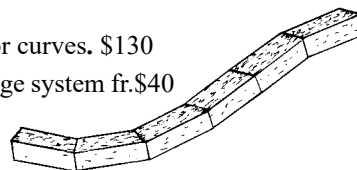

## *AC*

## ACCESSORIES

### STAR POSTS

1.35m Metal..... \$8  
1.65m Metal ..... \$9.50  
1.8 m Metal ..... \$10.50

### Protectex Timber Preserver

*Necessary for when Treated Pine is cut.*

1 L ..... \$18.50

### POST SUPPORTS -100mm

150mm Depth Gal.....\$11  
230mm Depth Gal.....\$13

*We have a full range of Cup Head Bolts, Galvanised & Steel Deck Spikes & Coach Screws ; Please enquire.*

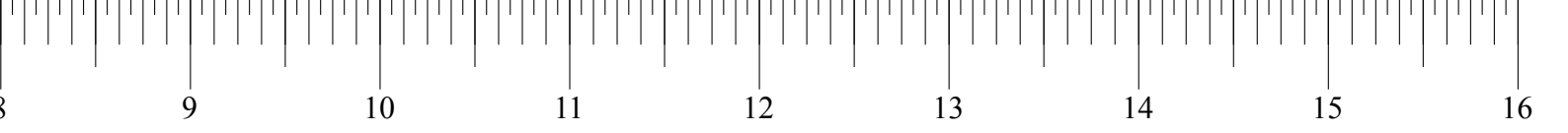

**TI**

**TREATED PINE SUPERLOGS**

**PERFECT ROUNDS - Precession Super logs with No Taper**

Diameter	Code	1.8m	2.4m	3m	3.6m
80mm	Red	\$7	\$9	\$12	discount price
100mm	White	\$ 12.50	\$16.50	\$19.65	\$25
125mm	Yellow	\$18	\$23.75	\$29	\$37
150mm	Blue	\$26.20	\$36.75	\$42.50	\$48.88
175mm	Natural	\$34	\$45	\$54.75	
200mm	Black	\$52	\$66	\$82	

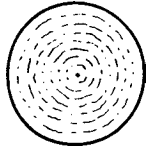

**HALF ROUNDS**

100mm		\$7.98	\$9.85	\$11.90
125mm		\$10.50	\$13.95	



**TREATED SLABS**

*Budget Slabs also avail in 2.4m- pak lots only.*

100mm		\$18.75	\$24.75	\$31.50
125mm		\$27	\$35.85	

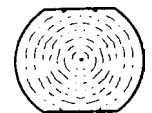

**WINGED SPLITS**

100mm		\$11.63	\$13.68	\$16.55
125mm	Yellow	\$15.91	\$19.75	



**10% OFF!**  
**WHEN YOU BUY 30 OR MORE LOGS!**

**SAND PIT KITS** Easy to erect and twice as fun to play in. Includes everything : Treated Pine W.Splits (for safety as W. splits have rounded edges), Spikes, Liner & Sand.

- 1.8m x 1.8m x 200mm.....\$165
- 2.4m x 2.4m x 200mm.....\$179

**Vegie Garden Bed** As above plus Ultra GrowGarden Soil !

- 2.4 x 1.8m x 200mm .....\$165 plus delivery

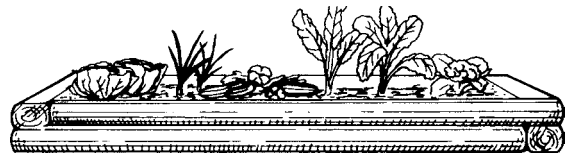

**About our Superlogs Treated Pine**

There are 5 treatment levels for pine ranging from H2 to H6, with H3 the minimum that should be used in wet areas (ie. all outdoor applications). All levels are treated to protect against termite attack so that when eaten the insect will eventually die. The SUPERLOG treatment also contains a repelling agent that deters termites from even trying the logs! All pine is treated to only about 80% of the cross section of the timber, but includes the entire (both) ends. When cut, the resultant exposed end grain should always be left out of the ground and be re-treated as this is the most likely area for both termites to attack & decay due to moisture. At BHLS we only sell H4 logs or higher.

**TI**

**CCA TREATED SAWN PINE TIMBER**

**REBATE FRAMING** 70mm x 35mm (Depth = 15mm)....\$5.50 per Ln M.

**LATTICE - Fine sawn (lath size = 38mm x 10mm)**

size mm	size feet	closed square	10% off with 3+ sheets	closed diagonal	
1.8 x 600	6 x 2	\$14.25*	\$12.83		*available on special order
1.8 x 900	6 x 3	\$21.40	\$19.26		
1.8 x 1200	6 x 4	\$28.50	\$25.65		
1.8 x 1800	6 x 6	\$42.75	\$38.48		
2.4 x 600	8 x 2	\$19	\$17.10	*	
2.4 x 900	8 x 3	\$28.50*	\$25.65	*	
2.4 x 1200	8 x 4	\$38	\$34.20	*	
2.4 x 1800	8 x 6	\$57	\$51.30	*	

## Ky TURF

Our Turf is *farm cultivated & weed free* in 1m2 rolls, generally 600mmx1.7m but can vary to 450mmx2.2m .

	1-24m	25-99	100+m
<i>Kykuyu Eureka update</i>	\$5.50	\$5	\$4.50
<i>Couch - Greenleas Park</i>	\$6.95	\$5.50	\$4.95
<i>Couch Nullabor</i>	\$6.95	\$5.50	\$4.95
<i>Buffalo - Sapphire</i>	\$9	\$8.50	\$7.40
<i>Buffalo Sir Walter</i>	\$10.50	\$9.50	\$8.50
<i>Buffalo Matilda</i>	\$10.90	\$9.90	\$8.90

## DRAINAGE

Ensure that you have adequate drainage behind the retaining walls by using a slotted sub surface drain, commonly called an **AGFLEX DRAIN**, at its base.

Make sure you have adequate coverage of aggregate under, at the sides & over the pipe & if you intend to turf or establish a garden, use **BIDUM** cloth over the aggregate.

By the Australian Std Guidelines, you will need **1 Tonne of Agg per 10m sub surface drain.**

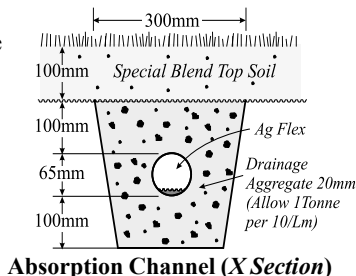

## AM TILES - Floor & Wall

Amber Kellyville's new tile showroom is now open! Drop in to see the latest indoor looks from Australia and overseas.

You'll find stunning wall and floor tiles in a fabulous range of finishes including natural stone, porcelain, ceramic and glass.

A professional design consultant and colourist are on staff to assist with design advice and colour selection.

The new store is user friendly with displays showing a variety of colour, size and texture combinations to make visualisation of the end result easy.

Call into Amber Kellyville for inspired ideas for the great indoors because, Amber has the answer.



Displays throughout the store highlight products such as natural stone (above). Sample cupboards allow customers to 'play' with design ideas.

## TI SLEEPERS

All 2.4m long.	Hardwood	Treated Pine
200mm x 100mm..8X4"	\$26	\$29
200 x 75..... 8X3"	-	\$24.50
150 x 100.... 6X4"	-	\$24.50
150 x 75.... 6X3"	-	\$19

**Edge Boards-** We make a distinction between Edgeboards & Sleepers as any timber >75mm will WARP if used above ground. We **don't recommend** Edgeboards above ground!

200 x 50.....8X2" (Edge Boards)	\$19.85-2.4m
200 x 50.....8X2" (Edge Boards)	\$24.75-3m
100 x 25.....4X1" (Edge Boards)	\$16-4.8m

Pack discount apply to some sleepers; please enquire.

## TI OLD SLEEPERS

While all care is taken in the selection of our hardwood, we strongly recommend that you **treat** to neutralise any organisms present.

# AMBER

has the answer

You will discover the largest range of pavers at **better than** factory prices!

Buying pavers from **AMBER Kellyville & Baulkham Hills Landscape Supplies** is hassle-free because you can compare brands in one place AND have peace of mind that you are selecting from the **BEST** brands available PLUS we can supply you with the sub-base materials all in the one deal! At any time, we have at **least 167 different** brands\colours so **job lots** at colour matching is not a problem.

### PAVING BONUS PACK

When you purchase 56m+ you will receive....

- \* **FREE** Helpful advice & "How to Fact Sheets"
- \* **FREE** Bag of joint filling sand for "topping up"
- \* **\$2 off (per tonne)** on Paving Blend & Road Base.

